



700 Hickory Street Pewaukee, WI 53072
 Phone 800-234-0337 Fax 262-691-3255
 www.goffscurtainwalls.com

Distributor:

Contact Name:

Contact Number:

G2 Model 5400 door dimensional drawing

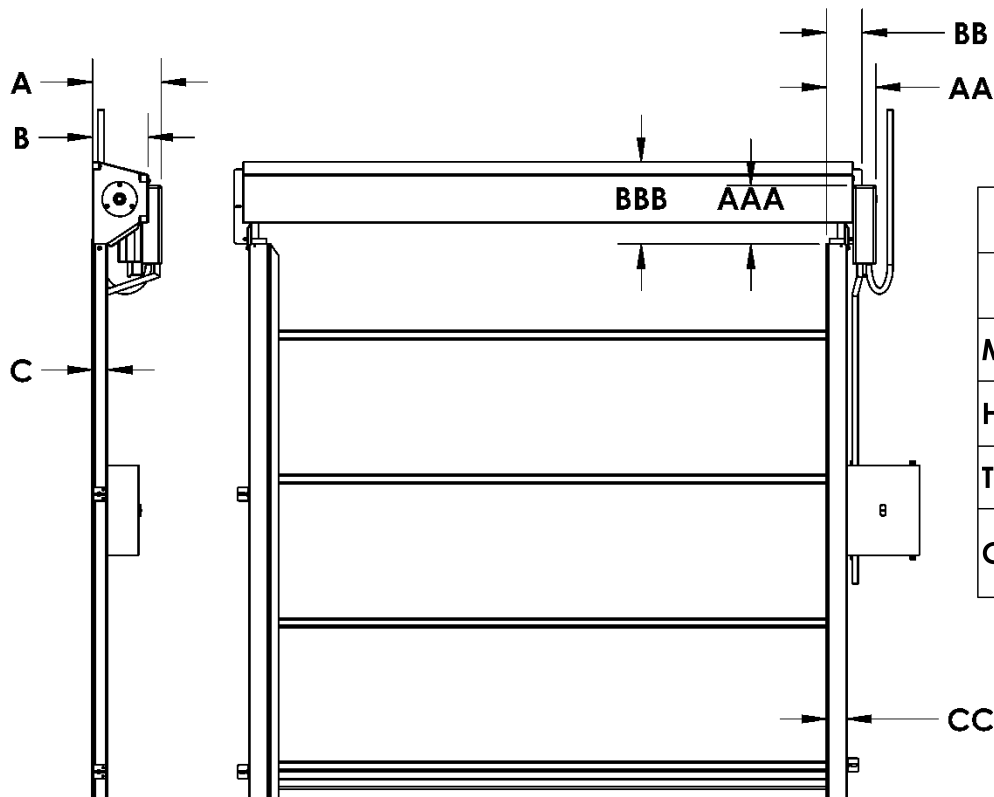

| G2 5400 | | | |
|---|-----------|----------------------|---------------|
| DIMENSION | FROM WALL | WIDTH OF OPENING | ABOVE OPENING |
| MOTOR | A-12" | AA- 9" DRIVE SIDE | AAA- 10-1/4" |
| HEADER BOX | B-9-3/4" | BB- 7" EACH SIDE | BBB- 14-1/4" |
| TRACK | C-2-3/4" | CC- 3-3/4" EACH SIDE | N/A |
| CONTROL PANEL - 14" WIDE x 16" HIGH x 8-1/2" DEEP | | | |